

## PRODUCT DESCRIPTION

The T-Grid Frame offers an innovative design with an LED module that fits directly into any 2x2 or 2x4 grid ceiling. The “edge lit” look provides a modern and unique look for a variety of applications such as offices or hospitality spaces. With 125 lumens per watt, the T-Grid Frame is a direct replacement for your standard 2x2 or 2x4 fixture.



## ORDER STRUCTURE

[EXAMPLE: TGF/2/40W/30K/AL]

PRODUCT CATEGORY	LENGTH	FIXTURE WATTAGE	CCT
STANDARD TGF = TGrid Frame	2 = 2FT 4 = 4FT	40w = 2FT 55w = 4FT	35 = 3500k    40 = 4000k

[EXAMPLE: TGF/2/W/K/ADJ-AL]

PRODUCT CATEGORY	LENGTH	FIXTURE WATTAGE / CCT
ADJUSTABLE TGF = TGrid Frame	2 = 2FT 4 = 4FT	W/K/ADJ= WATTAGE/COLOR ADJUSTABLE

## FIXTURE ORDER CODES

ORDER CODE	MODEL NUMBER	DLC PRODUCT ID	LENGTH	WATTAGE	CCT
50334-AL	TGF/2/W/K/ADJ-AL	PLEJFMQFPGD7	2 FT	Tunable 20-30-40W	Tunable 30-35-40K
50337-AL	TGF/4/55W/35K/AL	PLR78STN0XLW	4 FT	55W	3500K
50338-AL	TGF/4/55W/40K/AL	PL95L6N53Q2O		55W	4000K

## SPECIFICATIONS

SPECIFICATIONS		TGF-2 FT	TGF- 4 FT
		ADJUSTABLE WATTAGE/CCT	SINGLE COLOR CCT
GENERAL PERFORMANCE	Input Power (W)	TUNABLE 20-30-40 WATTS	55 WATTS
	Luminous Flux	2500 - 5000 LM	6875LM
	CRI	>80	80
	CCT	TUNABLE 30-35-40K	3500K/4000K
	Efficacy	125LPW	125LPW
	Beam Angle	120	120
	Dimming	0-10V DIMMING	0-10V DIMMING
	Standard Lifetime	50,000 HOURS	50,000 HOURS
ELECTRICAL	Input Voltage	100-277V	100-277V
	Power Factor	>0.95	>0.95
	Driver	Included, 7.5"L x 3.5"W x 1.375"D	Included, 7.5"L x 3.5"W x 1.375"D
	Emergency Backup	Available, sold separately	Available, sold separately
	IP Rating	IP40	IP40
PHYSICAL	Length	23.74"	47.76"
	Width	23.74"	23.74"
	Mounting	Grid Inlay (Recessed)	Grid Inlay (Recessed)
	Cord Length	16.5"	16.5"
CERTIFICATION	Certification	ETL, DLC	ETL, DLC
	Warranty	5 YEARS	5 YEARS

## DRIVER HANGER OPTION



Driver Bar Dimensions: 3.5" x 24"

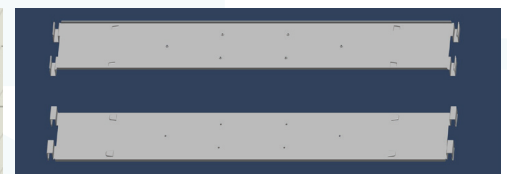

## DIMENSIONS

2' x 2'

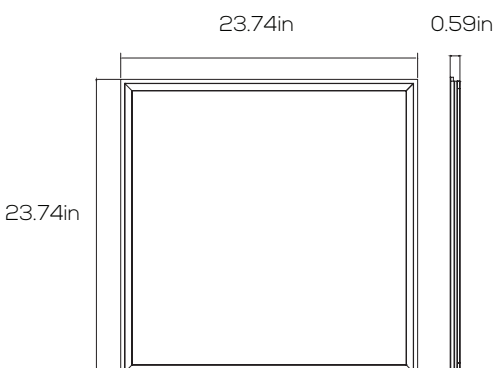

2' x 4'

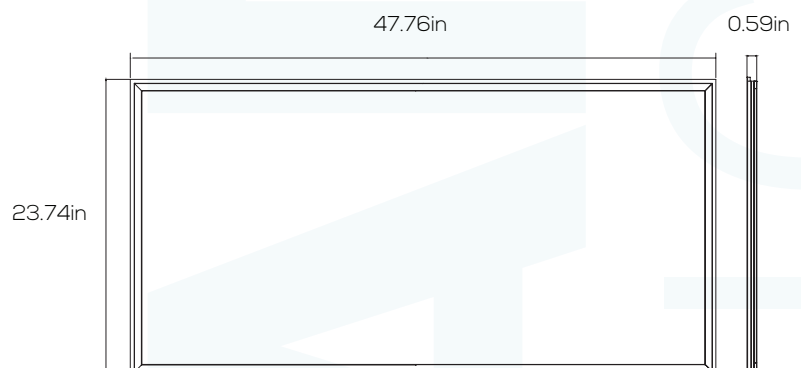

**PHOTOMETRICS**

**2' X 2'  
STANDARD**

**LUMINOUS INTENSITY DISTRIBUTION DIAGRAM**

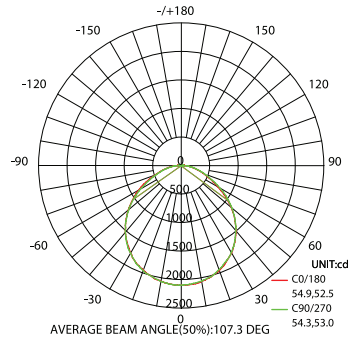

**ISOLUX DIAGRAM**

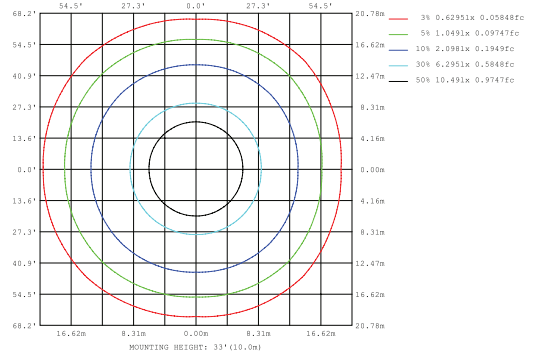

**LIGHT DISTRIBUTION CURVE**

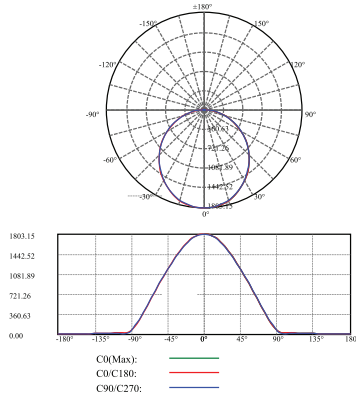

**2' X 2'  
CCT CHANGEABLE**

**LUX DISTANCE CURVE**

**LUMINOUS INTENSITY DISTRIBUTION DIAGRAM**

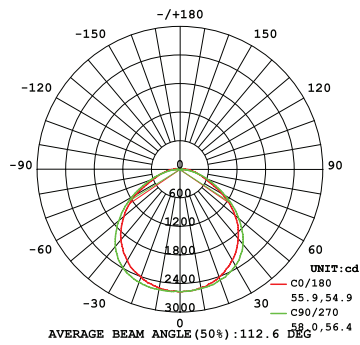

**2' X 4'  
STANDARD**

**ISOLUX DIAGRAM**

